



a xylem brand

High Water Bilge Alarm

INSTRUCTION MANUAL

- FR** Manuel d'instruction pour système d'alarme de niveau d'eau de cale
- DE** Bedienungsanleitung für Hochwasser-Bilgenalarmsystem
- IT** Manuale delle istruzioni per l'allarme di sentina in acqua alta
- NL** Handleiding lens hoogwateralarm
- SE** Användarhandledning för hög vattennivå i motorrummet
- ES** Manual de instrucciones de la alarma de inundación de sentina



CAUTION



Disconnect power from the system before working on the unit to avoid personal injury, damage to the surrounding environment and/or damage to the unit.

MISE EN GARDE



FR

Déconnecter la source d'alimentation électrique du système avant d'effectuer toute réparation ou entretien pour éviter les blessures et d'endommager l'environnement alentours et/ou l'unité.

VORSICHT



DE

Zur Vermeidung von Verletzungen, Umgebungs- und/oder Gerätebeschädigung vor jeglichen Arbeiten an der Einheit die Stromzufuhr trennen.

ATTENZIONE



IT

Per evitare infortuni alla persona, danni all'ambiente circostante e/o all'unità, staccare sempre l'alimentazione dal sistema prima di lavorare sull'unità.

VOORZICHTIG



NL

Schakel de stroomtoevoer naar het systeem uit voordat u aan de unit begint te werken. Dit om persoonlijk letsel, schade aan de omgeving en/of de unit te voorkomen.

VAR FÖRSIKTIG



SE

Koppla från strömtillförseln från systemet innan du börjar arbeta på enheten för att undvika personskada, skada på omgivningen och/eller produktskada.

PRECAUCIÓN



ES

Desconecte la alimentación eléctrica del sistema antes de trabajar en la unidad, a fin de evitar lesiones personales, daños al medio ambiente circundante y/o a la unidad.

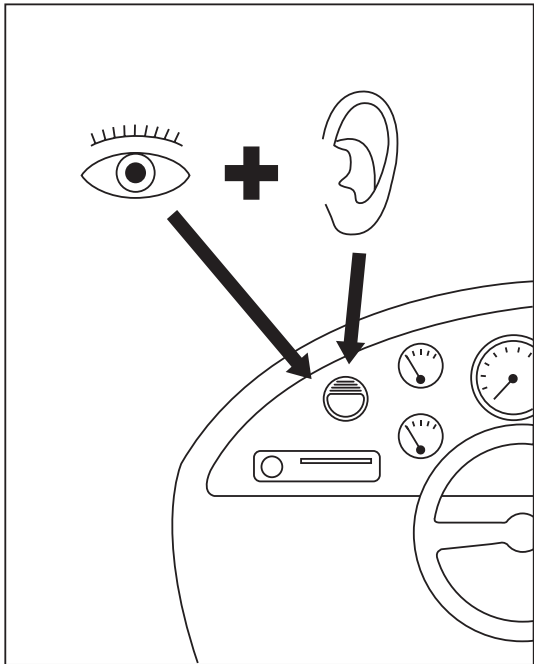

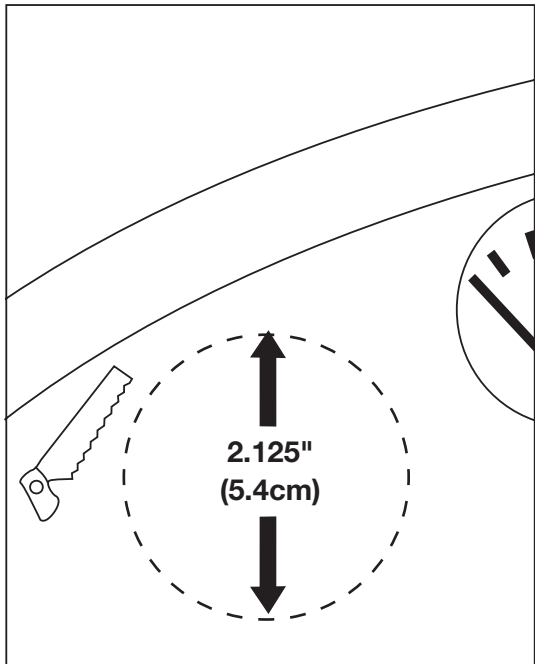

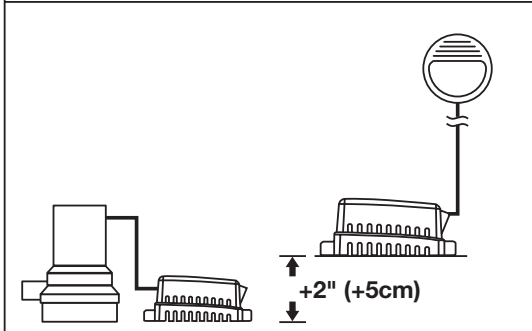
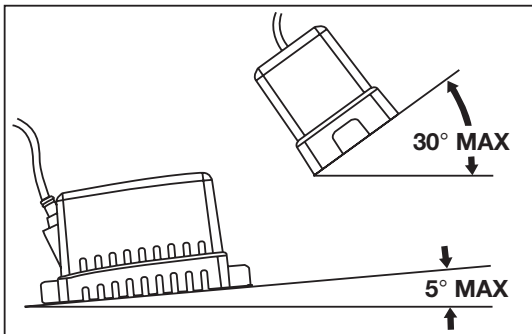

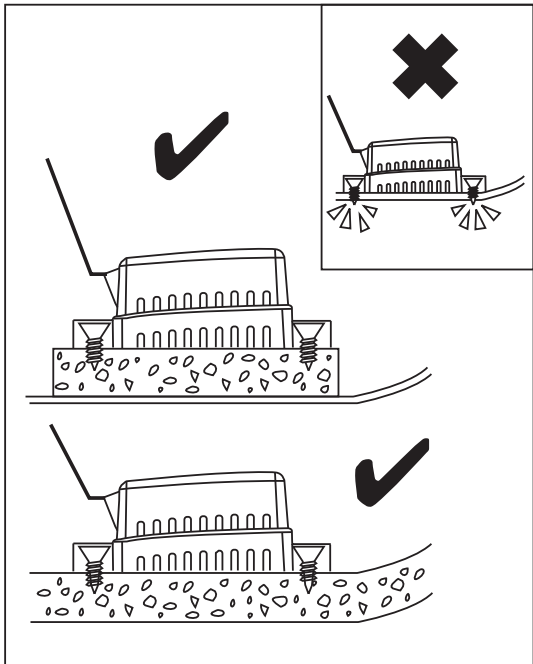

TESTING THE FLOAT SWITCH

- FR** Tester l'interrupteur à flotteur
- DE** Prüfen des Schwimmerschalters
- IT** Prova dell'interruttore galleggiante
- NL** De vlotterschakelaar testen
- SE** Testa flottörkontakten
- ES** Prueba del interruptor de flotador

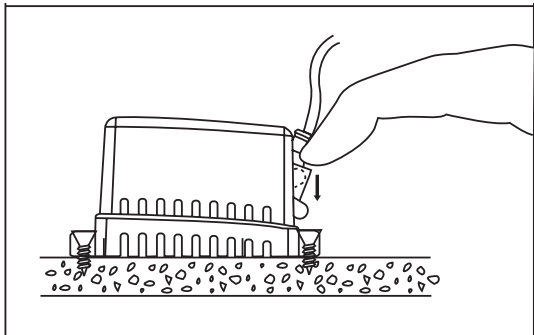

CAUTION



Always install proper fuse size to prevent damage to product should a short occur. Failure to install proper fuse could increase risk of pump malfunction potentially resulting in personal injury and/or fire hazard.

MISE EN GARDE



FR

Toujours installer la taille de fusible appropriée pour éviter d'endommager le produit en cas de court-circuit, faute de quoi la pompe pourrait mal fonctionner et entraîner des blessures et/ou des dangers d'incendie.

VORSICHT



DE

Immer die richtige Sicherungsstärke installieren, um im Fall eines Kurzschlusses eine Beschädigung des Geräts zu vermeiden. Die Verwendung der falschen Sicherungsstärke kann zu einem Versagen der Pumpe und damit möglicherweise zu Verletzungen und/oder Feuergefahr führen.

ATTENZIONE



IT

Per evitare danni al prodotto in caso di cortocircuito, installare sempre fusibile della dimensione corretta. Se viene installato un fusibile scorretto, il rischio di malfunzionamento della pompa aumenta, con il pericolo d'infortunio alla persona e/o d'incendio.

VOORZICHTIG



NL

Monteer altijd de juiste zekering om schade te voorkomen aan het product bij kortsluiting. Nalaten de juiste zekering te installeren, kan het risico op storingen aan de pomp verhogen, met eventueel persoonlijk letsel en/of brandgevaar tot gevolg.

VAR FÖRSIKTIG



SE

Installera alltid rätt säkringsstorlek för att produktskada ifall av kortslutning. Underlåtelse att installera rätt säkring kan öka risken för pumpfel med ris för personskada och/eller brand som resultat.

PRECAUCIÓN



ES

Instale siempre fusibles de tamaño apropiado para evitar daños al producto en caso de cortocircuito. Si no se instala el fusible del tamaño adecuado, puede aumentar el riesgo de fallas de la bomba que pueden ocasionar potencialmente lesiones y/o peligros de incendio.

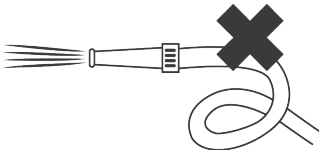

- RED - POSITIVE
- ROUGE - POSITIF
- ROT - POSITIV
- ROSSO - POSITIVO
- ROOD - POSITIEF
- RÖD - POSITIV
- ROJO - POSITIVO

- 1 AMP FUSE
- FUSIBLE DE 1 AMP.
- 1 AMP SICHERUNG
- FUSIBILE 1 AMP
- 1 AMP ZEKERING
- 1 A SÄKRING
- FUSIBLE DE 1 A

- BLACK - NEGATIVE
- NOIR - NÉGATIF
- SCHWARZ - NEGATIV
- NERO - NEGATIVO
- ZWART - NEGATIEF
- SVART - NEGATIV
- NEGRO - NEGATIVO

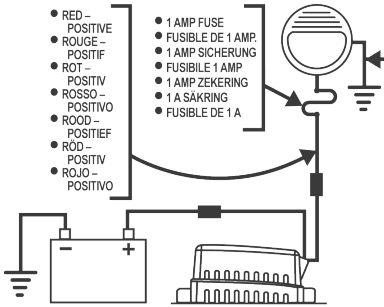

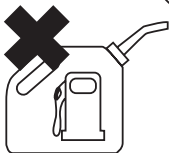
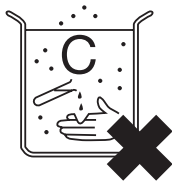

All mounting holes must be sealed with a marine grade sealant to prevent water intrusion.



FR Tous les trous de fixation doivent être rendus étanches à l'aide d'un mastic marine pour éviter toute pénétration d'eau.

DE Alle Montagebohrungen müssen mit einem für Marineanwendungen geeigneten Dichtmittel abgedichtet werden, um das Eindringen von Wasser zu verhindern.

IT Per evitare l'intrusione dell'acqua, sigillare tutti i fori di montaggio con un sigillante di qualità marina.

NL Een zeewatervaste kit moet voor alle montageopeningen gebruikt worden om indringing van zeewater te vermijden.

SE Alla monteringshål måste förseglas med ett tätningemedel för båtar för att hindra vatten från att tränga in.

ES Todos los orificios de montaje deben sellarse con un sellador de grado marino para evitar la entrada de agua.

ABYC
Setting Standards for Safer Boating

**Install to ABYC standards
H-22 and E11**

FR Installation conformément aux normes H-22 et E11 de ABYC.

DE In Übereinstimmung mit den ABYC-Normen H-22 und E-11 installieren.

IT Installare secondo gli standard ABYC H-22 e H-11.

NL Installeren volgens ABYC normen H-22 en E11

SE Installera i enlighet med ABYC-standard H-22 och E11.

ES Instalar según las normas H-22 y E11 del ABYC.



CE Logo

When this product carries a CE mark, it conforms to one or more of the following standards: EN 61000-6-1:2001 EN 61000-6-3:2007 Following the Provisions of the Electromagnetic Compatibility Directive 2004/108/EC

ISO 8846 / Electrical Devices Protection Against Ignition of Surrounding Flammable Gases

ISO 10133:2000 / Electrical Systems - Extra Low Voltage D.C. Installations Following the Provisions of the Recreation Craft Directive 94/25/EEC

CAUTION



Keep all wire connections above the highest water level. Wires must be joined with butt connectors and a marine grade sealant to prevent wire corrosion.

MISE EN GARDE

FR



Maintenir tous les raccords électriques au-dessus du niveau d'eau le plus élevé. Les fils doivent être raccordés avec des connecteurs bout à bout et un mastic marine pour empêcher la corrosion des conducteurs.

VORSICHT

DE



Darauf achten, dass sich alle Kabelverbindungen stets oberhalb des Wasserspiegels befinden. Drähte müssen mit Stoßverbindern verbunden und zum Rostschutz mit einem geeigneten Dichtmittel behandelt werden.

ATTENZIONE

IT



Mantenere tutti i collegamenti dei fili elettrici al di sopra del livello più alto dell'acqua. Per evitarne la corrosione, i fili elettrici devono essere congiunti con connettori a pressione diretta e sigillante specifico per uso marino.

VOORZICHTIG

NL



Houd alle draadverbindingen boven het hoogste waterniveau. De draden moeten worden samengehouden met een kabelverbinder en zeewatervaste kit. Dit om corrosie van de draden te voorkomen.

VAR FÖRSIKTIG

SE



Håll alla ledningsanslutningar ovanför den högsta vattennivån. Ledningar måste kopplas ihop med stumkontakter och förseglingsmedel för marint bruk för att förhindra ledningskorrosion.

PRECAUCIÓN

ES



Mantenga todas las conexiones de cables por arriba del máximo nivel del agua. Los cables deben empalmarse con conectores de tope y un sellador de grado marino, a fin de evitar la corrosión de los mismos.

	A	B	C
	Model	Volts	Max Amps
(FR)	Modèle	Volts	Amp. max.
(DE)	Modell	Volt	Max. Stromaufnahme
(IT)	Modello	Volt	Amp. max
(NL)	Model	Volt	Max. amp.
(SE)	Modell	Volt	Max. ampere
(ES)	Modelo	Voltios	Corriente máx.

A	B	C
33ALA	12V	20A
32ALA	24V	10A
31ALA	32V	6.5A

 a xylem brand

www.xylemflowcontrol.com

Rule is a trademark of Xylem Inc. or one of its subsidiaries.

© 2012 Xylem, Inc.

950-0524

Rev. C 10/2012