

4 in One: Fuel level gauge, Cooling water temperature gauge, Engine oil pressure gauge, Voltmeter	TU00-0752-9007102	03/11	1-6	1

## Safety information



- The product was developed, manufactured and inspected according to the basic safety requirements of EC Guidelines and state-of-the-art technology.
- The unit is designed for use in grounded vehicles and machines as well as in nautical sports, including non-classified commercial shipping.
- Use our product only as intended. Use of the product for reasons other than its intended use may lead to personal injury, property damage or environmental damage. Before installation, check the vehicle documentation for vehicle type and any possible special features!
- Use the assembly plan to learn the location of the fuel/hydraulic/compressed air and electrical lines!
- Note possible modification on the vehicle, which must be considered during installation!
- To prevent personal injury, property damage or environmental damage, basic knowledge of motor vehicle/shipbuilding electronics and mechanics is required.
- Make sure that the engine cannot start unintentionally during installation!
- Modifications or manipulations on the VDO product can affect safety. Consequently, you may not modify or manipulate the product!
- When removing/installing seats, covers, etc., ensure that lines are not damaged and plug-in connections are not loosened!
- Note all data from other installed units with volatile electronic memories.

### Safety during installation:

- During installation, ensure that the product's components do not affect or limit vehicle functions. Avoid damaging these components!
- Only install undamaged parts in a vehicle!
- During installation, ensure that the product does not impair the field of vision and that it cannot impact the driver's or passenger's head!
- A specialized technician should install the product. If you install the product yourself, wear appropriate work clothing. Do not wear loose clothing, as it may get caught in moving parts. Protect long hair with a hair net.
- When working on the on-board electronics, do not wear metallic or conductive jewelry such as necklaces, bracelets, rings, etc.
- If work on a running engine is required, exercise extreme caution. Wear only appropriate work clothing as you are at risk for personal injury resulting from being crushed or burned.
- Before taking any action, disconnect the negative terminal on the battery, otherwise you risk a short circuit. If the vehicle is supplied by auxiliary batteries, you must also disconnect the negative terminals on these batteries! Short circuits can cause fires, battery explosions and damages to other electronic systems. Please note that when you disconnect the battery all volatile electronic memories lose their input values and must be reprogrammed.
- If working on gasoline boat motors, let the motor compartment fan run before beginning work.
- Pay attention to how lines and cable harnesses are laid so that you don't drill or saw through them!
- Do not choose to install the product in the mechanical and electrical airbag area!
- Do not drill holes or ports in load-bearing or stabilizing stays or tie bars!
- When working underneath the vehicle, secure it according to the specifications from the vehicle manufacturer.
- Note the necessary clearance behind the drill hole or port at the installation location. Required mounting depth: 65 mm.
- Drill small ports; enlarge and complete them, if necessary using taper milling tools, saber saw, keyhole saw or file. Debur edges. Follow the safety instructions of the tool manufacturer.
- Use only insulated tools if work is necessary on live parts.

**No smoking! No open fire or lights!**

- Use only the multimeter or diode test lamps provided to measure voltages and currents in the vehicle/machine or ship. Use of conventional test lamps can cause damage to control units or other electronic systems.
- The electrical indicator outputs and cables connected to them must be protected from direct contact and damage. The cables in use must have sufficient insulation and electric strength and the contact points must be safe from touch.
- Use appropriate measures to also protect the electrically conductive parts on the connected consumer from direct contact. Laying metallic, uninsulated cables and contacts is prohibited.

### Safety after installation:

- Connect the ground cable tightly on the negative terminal of the battery.
- Reenter/reprogram the volatile electronic memory values.
- Check all functions.
- Use only clean water to clean the components. Note the Ingress Protection (IP) ratings (IEC 60529).

### Electrical connection:

- Note cable cross-sectional area!
- Reducing the cable cross-sectional area leads to higher current density, which can cause the cable cross-sectional area in question to heat up!
- When installing electrical cable, use the provided cable ducts and harnesses, however, do not run cables parallel to ignition cables or to cables that lead to large electricity consumers.
- Fasten cables with cable ties or adhesive tape. Do not run cables over moving parts. Do not attach cables to the steering column!
- Ensure that cables are not subject to tensile, compressive or shearing forces.
- If cables are run through drill holes, protect them using rubber sleeves or the like.
- Use only one cable stripper to strip the cable. Adjust the stripper so that stranded wires are not damaged or separated.
- Only use a soft soldering process or commercially available crimp connector to solder new cable connections!
- Only make crimp connections with cable crimping pliers. Follow the safety instructions of the tool manufacturer.
- Insulate exposed stranded wires to prevent short circuits.
- Caution: Risk of short circuit if junctions are faulty or cables are damaged.
- Short circuits in the vehicle network can cause fires, battery explosions and damages to other electronic systems. Consequently, all power supply cable connections must be provided with weldable connectors and be sufficiently insulated.
- Ensure ground connections are sound.
- Faulty connections can cause short circuits. Only connect cables according to the electrical wiring diagram.
- If operating the instrument on power supply units, note that the power supply unit must be stabilized and it must comply with the following standard: DIN EN 61000, Parts 6-1 to 6-4.

4 in One: Fuel level gauge, Cooling water temperature gauge, Engine oil pressure gauge, Voltmeter	TU00-0752-9007102	03/11	1-6	2

## Procedures for installing VDO Viewline instruments

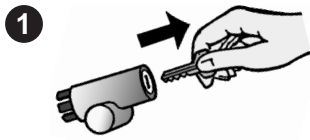

Before beginning, turn off the ignition and remove the ignition key. If necessary, remove the main circuit switch.

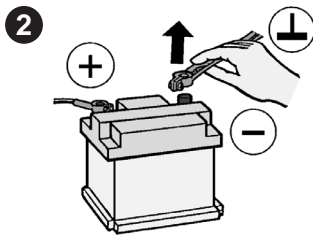

Disconnect the negative terminal on the battery. Make sure the battery cannot unintentionally restart.

- Before taking any action, disconnect the negative terminal on the battery, otherwise you risk a short circuit. If the vehicle is supplied by auxiliary batteries, you must also disconnect the negative terminals on these batteries! Short circuits can cause fires, battery explosions and damages to other electronic systems. Please note that when you disconnect the battery all volatile electronic memories lose their input values and must be reprogrammed.

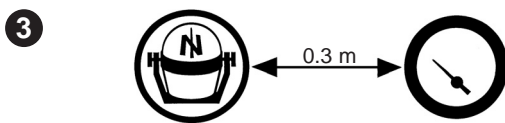

If installing the instrument near a magnetic compass, note the magnetic safe distance to the compass.



The following rings may be installed as alternatives to the supplied front ring:

Front ring, flat; black	A2C53210745
Front ring, flat; white	A2C53210746
Front ring, flat; chrome	A2C53210747
Front ring, triangular; black	A2C53210763
Front ring, triangular; white	A2C53210764
Front ring, triangular; chrome	A2C53210765
Front ring, round; black	A2C53210749
Front ring, round; white	A2C53210760
Front ring, round; chrome	A2C53210761

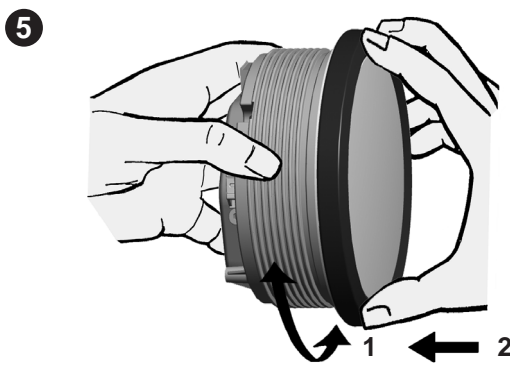

Place the new front ring on the instrument, rotate it until the ring's lip locks into the slots in the housing, and press the front ring until it is flush with the instrument glass.

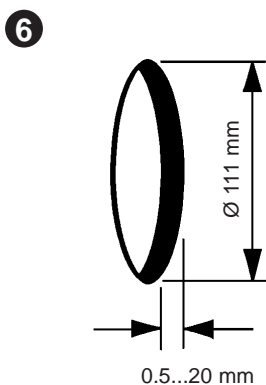

Conventional assembly. (Instrument is put into the drill hole from the front).

The panel width may be within a range of 0.5 to 20 mm. The drill hole must have a diameter of 111 mm.



- Do not drill holes or ports in load-bearing or stabilizing stays or tie bars!
- Note the necessary clearance behind the drill hole or port at the installation location. Required mounting depth: 65 mm.
- Drill small ports; enlarge and complete them, if necessary using taper milling tools, saber saw, keyhole saw or file. Debur edges. Follow the safety instructions of the tool manufacturer.

4 in One: Fuel level gauge, Cooling water temperature gauge, Engine oil pressure gauge, Voltmeter

TU00-0752-9007102

03/11

GB

1-6

3

7

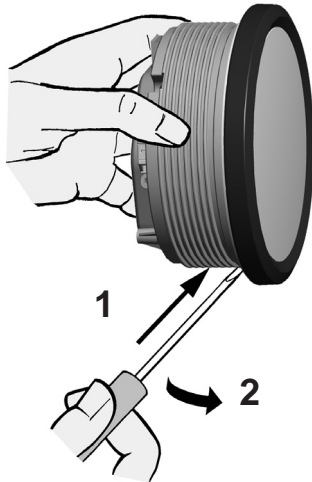

If the instrument will be mounted flush (i.e., from the back so that the instrument glass and the panel form one plane), the front ring must be removed. Press the instrument glass with both thumbs while at the same time pressing the front ring forward from the instrument with both index fingers. Note the use of a tool in the adjacent figure.

8

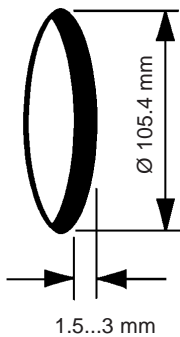

- Do not drill holes or ports in load-bearing or stabilizing stays or tie bars!
- Note the necessary clearance behind the drill hole or port at the installation location. Required mounting depth: 65 mm.
- Drill small ports; enlarge and complete them, if necessary using taper milling tools, saber saw, keyhole saw or file. Debur edges. Follow the safety instructions of the tool manufacturer.

### Flush assembly.

The recommended panel thickness is 1.5 to 3 mm. The drill hole must have a diameter of 105.4 mm. Ensure that the installation location is level and has no sharp edges.

9

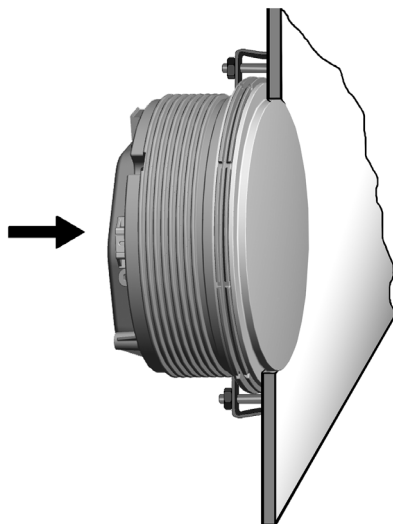

Place the flush mount seal A2C53215642 on the instrument glass. Put the instrument into the drill hole from the back. Adjust the instrument so that the gauge is level and fasten it to the stud bolts on the rear side of the panel using the flush mount fixing bracket A2C59510864.

4 in One: Fuel level gauge, Cooling water temperature gauge, Engine oil pressure gauge, Voltmeter

TU00-0752-9007102

03/11



1-6

4

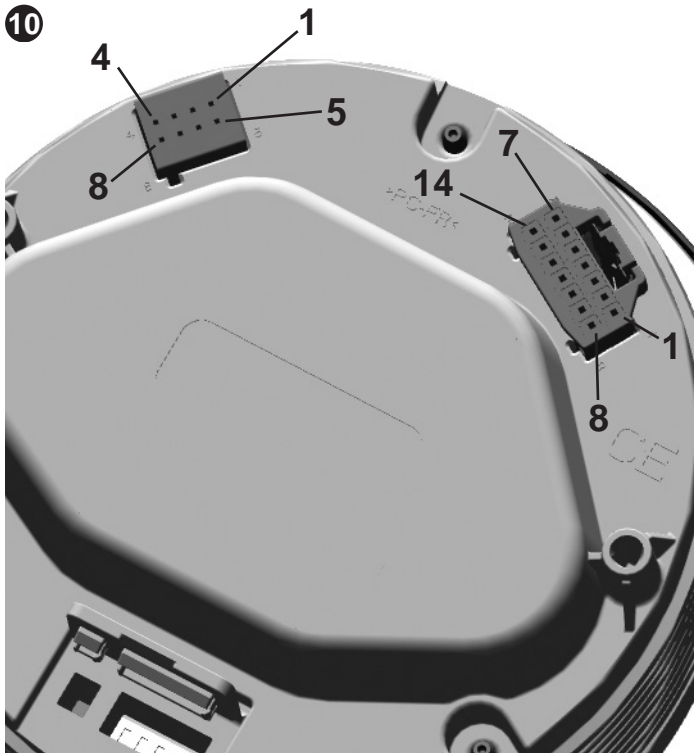

Depending on the configuration, insert the cable into the 8-pin and 14-pin contact housing according to the following pin assignment. The contacts must audibly lock into place.

### 8-pin contact housing

- Pin 1 - Term. 15 - ignition plus
- Pin 2 - Term. 31 - ground
- Pin 3 - Sensor ground
- Pin 4 - Sensor 3 - signal (fuel)
- Pin 5 - Sensor 1 signal (oil pressure)
- Pin 6 - Term. 58 - lighting
- Pin 7 - unassigned
- Pin 8 - Sensor 2 signal (cooling water temperature)

### 14-pin contact housing

- Pin 1 - warning LED 1 minus
- Pin 2 - warning LED 1 plus
- Pin 3 - 5 unassigned
- Pin 6 - warning LED 2 minus
- Pin 7 - warning LED 2 plus
- Pin 8 - warning LED 3 minus
- Pin 9 - warning LED 3 plus
- Pin 10 - warning LED 4 minus
- Pin 11 - warning LED 4 plus
- Pin 12 - warning LED 5 minus
- Pin 13 - warning LED 5 plus
- Pin 14 - unassigned

Now insert the plug into the gauge. Note the inverse polarity protection nose in the process.

11

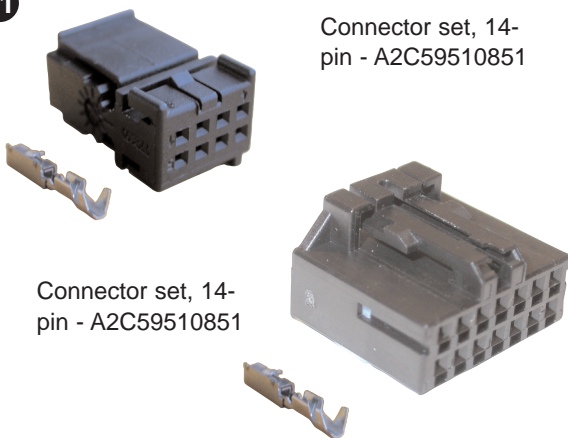

Use the following connector to connect the instrument:

Connector set, 8-pin - A2C59510850

Connector set, 14-pin - A2C59510851

The connector set is designed for a cable cross-section of 0.25 - 0.5 mm<sup>2</sup>.

For other cross-sections, please use contacts made by Tyco.

Single contacts: Tyco No. 1355718-1 for 0.14 – 0.22 mm<sup>2</sup>

Tyco No. 963729-1 for 0.5 – 0.75 mm<sup>2</sup>

Strip: Tyco No. 1355717-1 for 0.14 – 0.22 mm<sup>2</sup>

Tyco No. 963715-1 for 0.5 – 0.75 mm<sup>2</sup>

Create a crimp connection using the contacts and the corresponding cables. Follow the instructions of the hand pliers manufacturer. Use the following for this:

Hand pliers Tyco No. 539635-1

And the tool Tyco No. 539682-2 for these hand pliers.

Pay special attention to whether the crimp barrel clutches all individual wires in the cable, otherwise you risk a short circuit!



### Electrical connection:

- Note cable cross-sectional area!
- Reducing the cable cross-sectional area leads to higher current density, which can cause the cable cross-sectional area in question to heat up!
- When installing electrical cable, use the provided cable ducts and harnesses, however, do not run cables parallel to ignition cables or to cables that lead to large electricity consumers.
- Fasten cables with cable ties or adhesive tape. Do not run cables over moving parts. Do not attach cables to the steering column!
- Ensure that cables are not subject to tensile, compressive or shearing forces.
- If cables are run through drill holes, protect them using rubber sleeves or the like.
- Use only one cable stripper to strip the cable. Adjust the stripper so that stranded wires are not damaged or separated.
- Only use a soft soldering process or commercially available crimp connector to solder new cable connections!
- Only make crimp connections with cable crimping pliers. Follow the safety instructions of the tool manufacturer.
- Insulate exposed stranded wires to prevent short circuits.
- Caution: Risk of short circuit if junctions are faulty or cables are damaged.
- Short circuits in the vehicle network can cause fires, battery explosions and damages to other electronic systems. Consequently, all power supply cable connections must be provided with weldable connectors and sufficiently insulated.
- Ensure ground connections are sound.
- Faulty connections can cause short circuits. Only connect cables according to the electrical wiring diagram.
- If operating the instrument on power supply units, note that the power supply unit must be stabilized and it must comply with the following standard: DIN EN 61000, Parts 6-1 to 6-4.

4 in One: Fuel level gauge, Cooling water temperature gauge, Engine oil pressure gauge, Voltmeter	TU00-0752-9007102	03/11	1-6	5

- 12** Designations in the wiring diagram:  
 30 - terminal 30 - steady-state plus 12 V  
 15 - terminal 15 - connected (ignition) plus  
 58 - terminal 58 - lighting  
 31 - terminal 31 - ground
- F1 - fuse 5A quick-response  
 S1 - Warning contact 1  
 S2 - Warning contact 2  
 S3 - Warning contact 3  
 S4 - Warning contact 4
- S5 - Warning contact 5  
 C1 - 8-pin MQS connector  
 You must comply with the wiring diagram.

### 8-pin connection

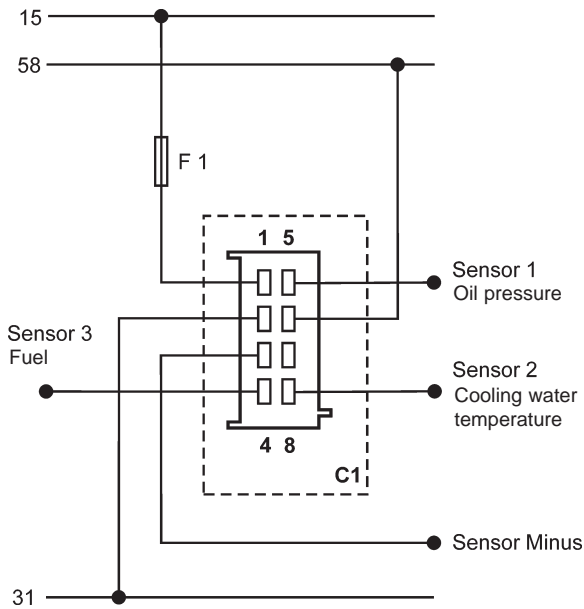

### 14-pin connection

Warning contact Minus controlled

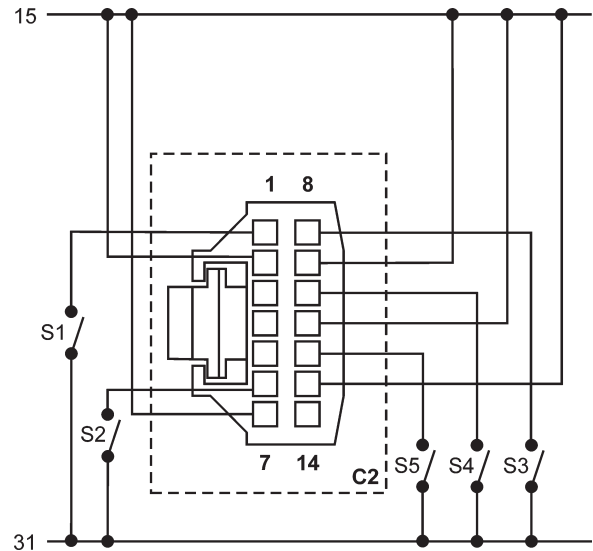

### 13

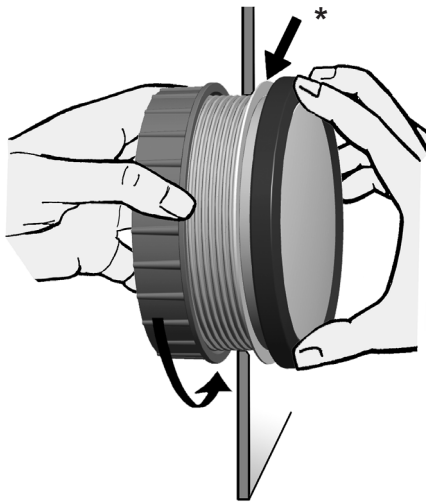

Align the instrument and hand-tighten the fastening nut. Ensure that the nut is not tightened with a torque greater than 400 Ncm.

\* Make sure the seal lays flat between the panel and the front ring.

### 14



If you would like to omit the fastening nut, you may use the part set A2C59510854 as an alternative. This is recommended if the installation location is subject to vibratory loads. Screw the stud bolts into the provided drill holes in the enclosure. Max. stud bolt torque is 1.5 Nm.

4 in One: Fuel level gauge, Cooling water temperature gauge, Engine oil pressure gauge, Voltmeter

TU00-0752-9007102

03/11

GB

1-6

6

15

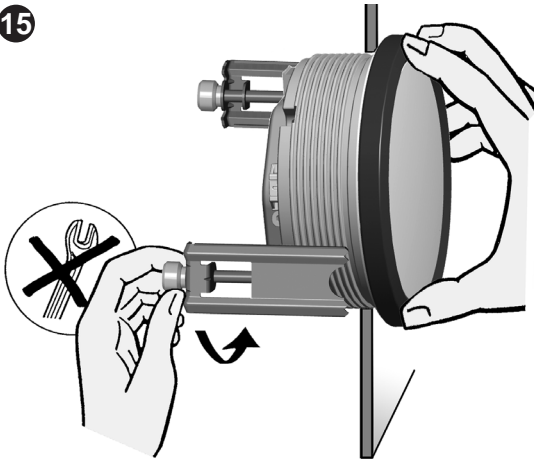

Place the bracket on the stud bolt and hand-tighten the knurled nut.

\* Make sure the seal lays flat between the panel and the front ring (see Fig. 13).

16

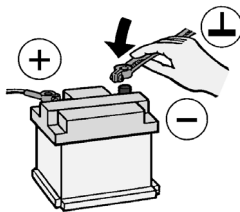

Reconnect the battery after inspecting the connection.



• Please note that when you disconnect the battery all volatile electronic memories lose their input values and must be reprogrammed.

17

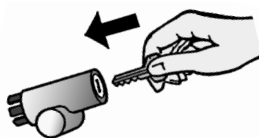

If necessary, replace the main circuit switch. Turn on the ignition and conduct a functional test.

Reprogram other instruments that may have lost their saved settings.

18

**Important:** Clean the instrument glass and front frame with water only. Do not use chemical agents.

19

**Accessories / Spare parts**

Bush contacts 0.25 – 0.5 mm <sup>2</sup>	A2C59510846	Flush mount fixing bracket	A2C59510864
Bush housing, 8-pin	A2C59510847	Flush mount seal	A2C53215642
Bush housing, 14-pin	A2C59510848	Fastening nut	A2C53238881
Protective connector cap, 8-pin	A2C53324664	Front ring, flat; black	A2C53210745
Protective connector cap, 14-pin	A2C53324671	Front ring, flat; white	A2C53210746
Hand pliers	Tyco No. 539635-1	Front ring, flat; chrome	A2C53210747
Tool for hand pliers	Tyco No. 539682-2.	Front ring, triangular; black	A2C53210763
Single contacts 0.14 – 0.22 mm <sup>2</sup>	Tyco No. 1355718-1	Front ring, triangular; white	A2C53210764
Single contacts 0.5 – 0.75 mm <sup>2</sup>	Tyco No. 963729-1	Front ring, triangular; chrome	A2C53210765
Strip 0.14 – 0.22 mm <sup>2</sup>	Tyco No. 1355717-1	Front ring, round; black	A2C53210749
Strip 0.25 – 0.5 mm <sup>2</sup>	Tyco No. 928999-1	Front ring, round; white	A2C53210760
Strip 0.5 – 0.75 mm <sup>2</sup>	Tyco No. 963715-1	Front ring, round; chrome	A2C53210761
Bracket assembly mounting set	A2C59510854		