



a xylem brand

Panel Switch

INSTRUCTION MANUAL

- FR** Manuel d'utilisation pour commutateur de panneau
- DE** Bedienungsanleitung für den Einbauschalter
- IT** Manuale delle istruzioni per l'interruttore a pannello
- NL** Handleiding paneelschakelaar
- SE** Användarhandledning för panelbrytare
- ES** Manual de instrucciones del conmutador de tablero



CAUTION Disconnect power from the system before working on the unit to avoid personal injury, damage to the surrounding environment and/or damage to the unit.



MISE EN GARDE Déconnecter la source d'alimentation électrique du système avant d'effectuer toute réparation ou entretien pour éviter les blessures et d'endommager l'environnement alentours et/ou l'unité.

FR



VORSICHT Zur Vermeidung von Verletzungen, Umgebungs- und/oder Gerätebeschädigung vor jeglichen Arbeiten an der Einheit die Stromzufuhr trennen.

DE



ATTENZIONE Per evitare infortuni alla persona, danni all'ambiente circostante e/o all'unità, staccare sempre l'alimentazione dal sistema prima di lavorare sull'unità.

IT



VOORZICHTIG Schakel de stroomtoevoer naar het systeem uit voordat u aan de unit begint te werken. Dit om persoonlijk letsel, schade aan de omgeving en/of de unit te voorkomen.

NL



VAR FÖRSIKTIG Koppla från strömtillförseln från systemet innan du börjar arbeta på enheten för att undvika personskada, skada på omgivningen och/eller produktskada.

SE



PRECAUCIÓN Desconecte la alimentación eléctrica del sistema antes de trabajar en la unidad, a fin de evitar lesiones personales, daños al medio ambiente circundante y/o a la unidad.

ES



CAUTION



This product must be fused with the recommended fuse size for the pump to which it is connected.

MISE EN GARDE



FR

Ce produit doit être équipé d'un fusible de taille recommandée pour la pompe à laquelle il est connecté.

VORSICHT



DE

Dieses Produkt muss mit einer Sicherung ausgestattet sein, welche die für die Pumpe, mit der es verbunden ist, empfohlene Sicherungsstärke aufweist.

ATTENZIONE



IT

Questo prodotto deve alloggiare il fusibile della dimensione raccomandata per la pompa alla quale è connesso.

VOORZICHTIG



NL

Dit product moet worden voorzien van de aanbevolen zekering voor de pomp waar hij is mee verbonden.

VAR FÖRSIKTIG



SE

Denna produkt måste förses med säkring av rekommenderad storlek för pumpen till vilken den är ansluten.

PRECAUCIÓN



ES

Este producto se debe proteger con un fusible del tamaño recomendado para la bomba a la que va conectado.

CAUTION



Always install proper fuse size to prevent damage to product should a short occur. Failure to install proper fuse could increase risk of pump malfunction potentially resulting in personal injury and/or fire hazard.

MISE EN GARDE



FR

Toujours installer la taille de fusible appropriée pour éviter d'endommager le produit en cas de court-circuit, faute de quoi la pompe pourrait mal fonctionner et entraîner des blessures et/ou des dangers d'incendie.

VORSICHT



DE

Immer die richtige Sicherungsstärke installieren, um im Fall eines Kurzschlusses eine Beschädigung des Geräts zu vermeiden. Die Verwendung der falschen Sicherungsstärke kann zu einem Versagen der Pumpe und damit möglicherweise zu Verletzungen und/oder Feuergefahr führen.

ATTENZIONE



IT

Per evitare danni al prodotto in caso di cortocircuito, installare sempre fusibile della dimensione corretta. Se viene installato un fusibile scorretto, il rischio di malfunzionamento della pompa aumenta, con il pericolo d'infortunio alla persona e/o d'incendio.

VOORZICHTIG



NL

Monteer altijd de juiste zekering om schade te voorkomen aan het product bij kortsluiting. Nalaten de juiste zekering te installeren, kan het risico op storingen aan de pomp verhogen, met eventueel persoonlijk letsel en/of brandgevaar tot gevolg.

VAR FÖRSIKTIG



SE

Installera alltid rätt säkringsstorlek för att produktskada ifall av kortslutning. Underlåtelse att installera rätt säkring kan öka risken för pumpfel med ris för personskada och/eller brand som resultat.

PRECAUCIÓN



ES

Instale siempre fusibles de tamaño apropiado para evitar daños al producto en caso de cortocircuito. Si no se instala el fusible del tamaño adecuado, puede aumentar el riesgo de fallas de la bomba que pueden ocasionar potencialmente lesiones y/o peligros de incendio.

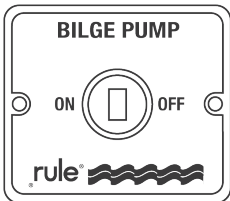

MODEL 49

- TO PUMP
- VERS LA POMPE
- ZUR PUMPE
- ALLA POMPA
- NAAR POMP
- TILL PUMP
- A LA BOMBA

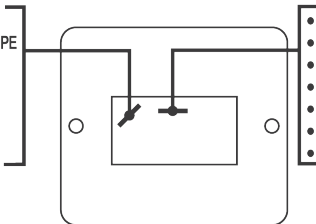

- POWER
- ALIMENTATION
- STROM
- ALIMENTAZIONE
- STROOM
- STRÖM
- ALIMENTACIÓN

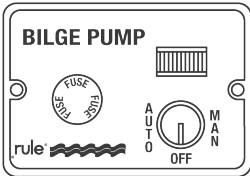

MODEL 41 (12V)
MODEL 42 (24V, 32V)

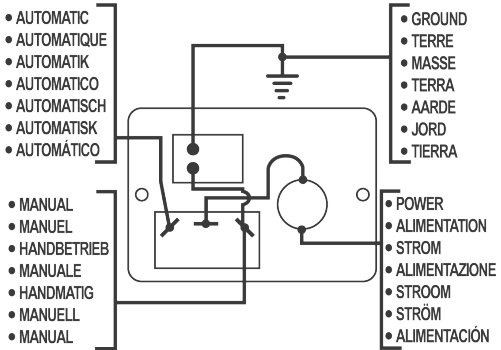

- AUTOMATIC
- AUTOMATIQUE
- AUTOMATIK
- AUTOMATICO
- AUTOMATISCH
- AUTOMATISK
- AUTOMÁTICO

- MANUAL
- MANUEL
- HANDBETRIEB
- MANUALE
- HANDMATIG
- MANUELL
- MANUAL

- GROUND
- TERRE
- MASSE
- TERRA
- AARDE
- JORD
- TIERRA

- POWER
- ALIMENTATION
- STROM
- ALIMENTAZIONE
- STROOM
- STRÖM
- ALIMENTACIÓN

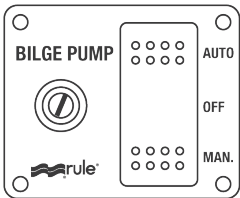

MODEL 43 (12V)
MODEL 44 (24V, 32V)

- MANUAL
- MANUEL
- HANDBETRIEB
- MANUALE
- HANDMATIG
- MANUELL
- MANUAL

- AUTOMATIC
- AUTOMATIQUE
- AUTOMATIK
- AUTOMATICO
- AUTOMATISCH
- AUTOMATISK
- AUTOMÁTICO

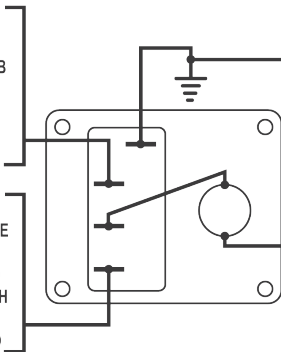

- GROUND
- TERRE
- MASSE
- TERRA
- AARDE
- JORD
- TIERRA

- POWER
- ALIMENTATION
- STROM
- ALIMENTAZIONE
- STROOM
- STRÖM
- ALIMENTACIÓN

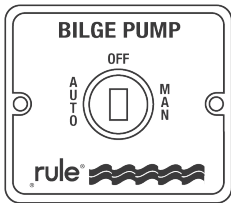

MODEL 45

- AUTOMATIC
- AUTOMATIQUE
- AUTOMATIK
- AUTOMATICO
- AUTOMATISCH
- AUTOMATISK
- AUTOMÁTICO

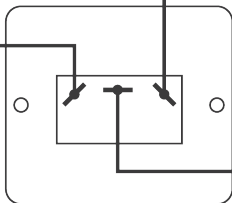

- MANUAL
- MANUEL
- HANDBETRIEB
- MANUALE
- HANDMATIG
- MANUELL
- MANUAL

- POWER
- ALIMENTATION
- STROM
- ALIMENTAZIONE
- STROOM
- STRÖM
- ALIMENTACIÓN

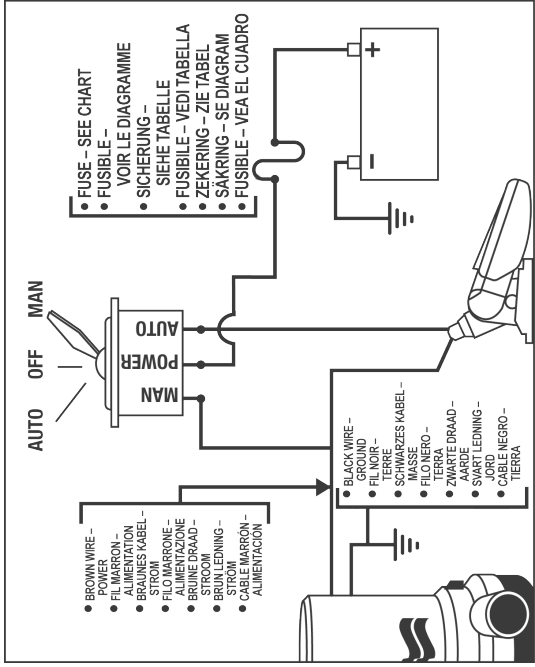

AUTO OFF MAN

- BROWN WIRE - POWER
- FIL MARRON - ALIMENTATION
- BRAUNES KABEL - STROM
- FILO MARRONE - ALIMENTAZIONE
- BRUINE DRAAD - STROOM
- BRUN LEDNING - STROM
- CABLE MARRÓN - ALIMENTACIÓN

- FUSE - SEE CHART
- FUSIBLE - VOIR LE DIAGRAMME
- SICHERUNG - SIEHE TABELLE
- FUSIBILE - VEDI TABELLA
- ZEKERING - ZIE TABEL
- SÄKRING - SE DIAGRAM
- FUSIBLE - VEA EL CUADRO

- BLACK WIRE - GROUND
- FIL NOIR - TERRE
- SCHWARZES KABEL - MASSE
- FILO NERO - TERRA
- ZWARTE DRAAD - AARDE
- SVART LEDNING - JORD
- CABLE NEGRO - TIERRA



www.xylemflowcontrol.com

Rule is a trademark of Xylem Inc. or one of its subsidiaries.

© 2012 Xylem, Inc.

950-0525

Rev. C 10/2012