

LINK UP GATEWAY RESISTIVE TYPE

OPERATING INSTRUCTIONS
rev. AA

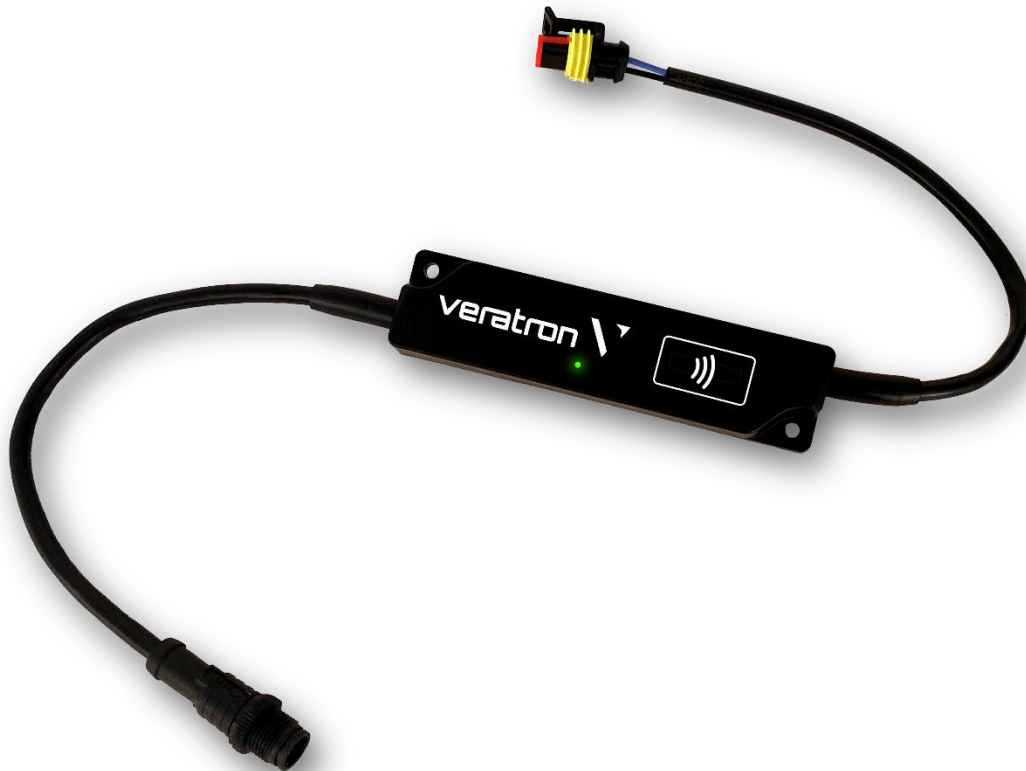

CONTENT

Introduction	3
<hr/>	
System installation	5
<hr/>	
Configuration	7
<hr/>	
Technical data	11
<hr/>	

INTRODUCTION

SYSTEM COMPONENTS



1x Link Up gateway (B00042201)

Interfaces the resistive-type analog sensors with the NMEA 2000® network to make all the information available for any display. Wireless configurable, the Link Up gateway can be easily set up with your smartphone and the Link Up configurator App.

THE LINK UP GATEWAY CONCEPT

The resistive-type Link Up gateway (hereinafter “Device” or “Link Up”) provide an easy method to convert vessel and engine information to NMEA 2000.

Compatible sensors are for example, but not only, liquid levels, temperature or pressure senders.

Easily installed, the LinkUp gateway replaces the original wiring, delivering power to both the LinkUp device and sensor from the NMEA 2000 backbone while still being compliant with the NMEA 2000 certification requirements.

The data are then available for being displayed on any OceanLink, AcquaLink, or more in general on any glass cockpit NMEA 2000 display device.

Configuring LinkUp gateways is simple using a mobile device and the companion LinkUp Configurator App for Android or iOS.

Each device has a built-in passive NFC antenna, so the parameters of the sensor are wirelessly configured to type, instance and warning threshold on the mobile device which is then “tapped” against the LinkUp device for instant data download.



DESIGN AND FUNCTION

The Link Up gateway has a simple but yet effective design.

The potted housing allows the unit to be installed in Engine Rooms, making it compliant to the ISO 8846:1990 as requested by the directive 2013-53(EC).

The standard NMEA 2000® M12 plug allows for a plug-and-play installation to the network backbone.

The sensor connection happens through an AMP Superseal plug, which perfectly matches the veratron level sensors, without the need of additional wiring (fig.1).



Figure 1:
Link Up connection to a veratron Dip-Pipe level sensor

SYSTEM INSTALLATION

BEFORE THE ASSEMBLY

1. Before beginning, turn off the ignition and remove the ignition key. If necessary, remove the main circuit switch.
2. Disconnect the negative terminal on the battery. Make sure the battery cannot unintentionally restart. Short circuits can cause fires, battery explosions and damages to other electronic systems.
3. Install the device at least 50cm away from any magnetic compass.
4. The Link Up must be mounted and handled in an ESD protected area.
5. The device may not be damaged.

CONNECT THE SENSOR

Depending on the sensor to be configured, connect the Link Up plug to the sensor according to the following pin assignment (fig.2).

If the sensor is not equipped with the matching connector, it is possible to either crimp a male counterpart on it (see "Technical Data"), or simply cut-off the sensor plug on the Link Up and manually connect the wires.

For the full list of supported sensors, please refer to Table 1.

Veratron level sensors are already designed with the mating AMP connector for a plug-and-play installation.

The contacts must audibly lock into place.

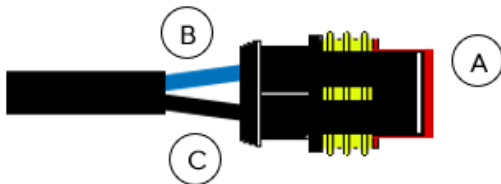

Figure 2:
Sensor plug on Link Up

- A. TE AMP Superseal 1.5 series female plug
- B. Blue wire – Sensor input
- C. Black wire – Sensor ground

SUPPORTED SENSORS

Fuel Level	Boost Pressure
Fresh Water Level	Oil Pressure
Waste Water Level	Oil Temperature
Trim Level	Gear Oil Pressure
Rudder Angle	Gear Oil Temperature
Coolant Temperature	Trim Tabs

Table 1:
List of supported sensor types

CONNECT TO THE NMEA 2000® NETWORK

Once the sensor installation is complete it is possible to interface the Link Up gateway to the NMEA 2000® backbone through the dedicated plug.

Please ensure to tighten the M12 connector by screwing it onto its counterpart, so to preserve the water tightness.

A drop cable is not needed unless the total length of the Link Up device is not enough to reach the NMEA 2000® backbone. In this case it is possible to extend the total length by using one of the accessory drop cables.

Please note that NMEA 2000® does not allow drop cables longer than 6 meters.

Refer to the NMEA 2000® standard for a proper network design.

If power from the NMEA 2000® network is received, the green LED on the Link Up housing will start flashing (see "LED notifications").



CONFIGURATION

LINK UP CONFIGURATOR APP

To configure the sensor, some parameters must be calibrated through the Link Up gateway, like sensor type, its calibration or warning threshold.

This is possible through the “Link Up Configurator” smartphone App, which can be downloaded free of charge from the stores of both Android and iOS devices.

A simple and detailed explanation of the configuration process is also available as in-app instructions.

Thanks to the passive embedded NFC receiver, the Link Up gateway can be configured, as described below, without the need of power supply.



**LINK UP
CONFIGURATOR**



Figure 4:
Link Up Configurator App is available for both iOS and Android devices

SENSOR CONFIGURATION



1. Launch the “Link Up Configurator” App and read the actual configuration of the Link Up device by “tapping” the smartphone onto the Link Up wireless area (indicated by the red arrow).

NOTE: The antenna position on the smartphone depends on the model. Please refer to the smartphone manufacturer manual.

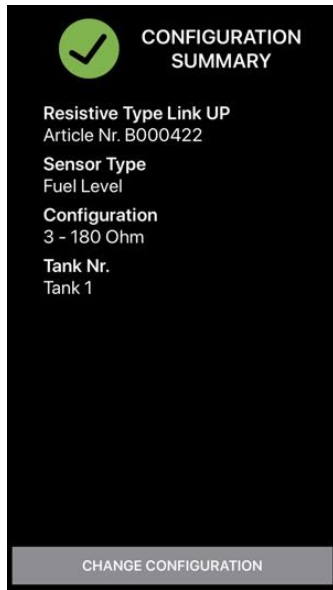

2. After the readout, the App will show the "Configuration Summary", which displays all the current settings of the device.

To modify the configuration, press the "Change Configuration" button.

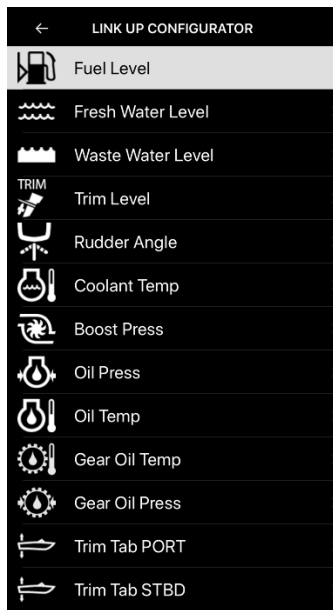

3. Select the sensor type to be configured among the list shown in the App (e.g. Fuel Level).

Then choose the calibration for the selected sensor (e.g. 3-180 Ω) and its instance (e.g. Tank 2) so that the Link Up gateway will correctly transmit the value over NMEA 2000®.

For some sensors (see list) it is possible to also set up an alarm, with its related threshold.

Once the settings are completed, press the "Write Configuration" button to prepare the download.

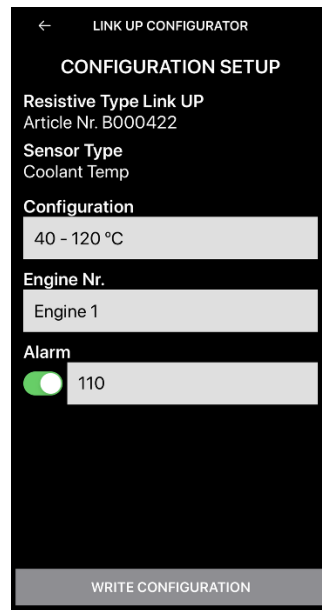

4. To download the configuration, simply "tap" the smartphone again onto the Link Up wireless area, as described on step 1.

The configuration is instantaneously transferred to the device, and the new "Configuration Summary" is displayed.



SUPPORTED CONFIGURATIONS*

Sensor Type	Calibrations	Alarm available	NMEA 2000® PGN
Fuel Level	0 – 90 Ω 3 – 180 Ω 240 – 33 Ω 90 – 4 Ω	No	127505
Fresh Water Level	3 – 180 Ω 240 – 33 Ω 90 – 4 Ω	No	127505
Waste Water Level	3 – 180 Ω 240 – 33 Ω 90 – 4 Ω	No	127505
Trim Position	167 – 10 Ω (Single station) 84 – 5 Ω (Dual station)	No	127488
Rudder Angle	10 – 180 Ω (Single station) 5 – 90 Ω (Dual station)	No	127245
Coolant Temperature	291 – 22 Ω (120 °C) 322 – 19 Ω (150 °C)	Yes	127489
Boost Pressure	10 – 184 Ω (2 bar) 10 – 184 Ω (5 bar)	No	127488
Oil Pressure	10 – 184 Ω (5 bar) 10 – 184 Ω (10 bar)	Yes	127489
Oil Temperature	322 – 19 Ω (150 °C)	Yes	127489
Gear Oil Pressure	10 – 184 Ω (10 bar) 10 – 184 Ω (25 bar) 10 – 211 Ω (30 bar)	Yes	127493
Gear Oil Temperature	322 – 19 Ω (150 °C)	Yes	127493
Trim Tabs	167 – 10 Ω (Single station) 84 – 5 Ω (Dual station)	No	130576

* the supported configurations may be updated at any time. Please make sure to always use the latest App version.

LED NOTIFICATION

LED behavior	Description
OFF	Device not powered.
ON	Device configured and in operation.
Slow blink (1Hz)	Device in operation with invalid or empty configuration. Waiting for configuration by the user (factory setting). NMEA 2000® messages are NOT transmitted.
Fast blink (5Hz)	Analogue value from the sensor out of range. NMEA 2000® messages are being set as "invalid".
Very fast blink (10Hz)	Device reconfiguration in progress after wireless download.

TECHNICAL DATA

LINK UP DATASHEET

Operating voltage	6 – 16.5 V
Nominal voltage	12 V (from NMEA 2000® network)
Power consumption	≤ 100 mA
NMEA 2000® LEN	2
Protection class	IP X7 according to IEC60529 (when connected)
Operating temperature	-30°C to 80°C
Flammability	UL94-HB
Sensor cable length	25 cm
NMEA 2000® cable length	25 cm
Sensor plug	TE AMP Superseal 1.5 2 pins - Female Housing: 282080-1 Terminals: 282403-1 (2x) Sealing: 281934-2 (2x)
Counterpart for sensor plug	TE AMP Superseal 1.5 2 pins - Male Housing: 282104-1 Terminals: 282404-1 (2x) Sealing: 281934-2 (2x)
NMEA 2000® plug	DeviceNet Micro-C M12 5 pins - Male

DIMENSIONS

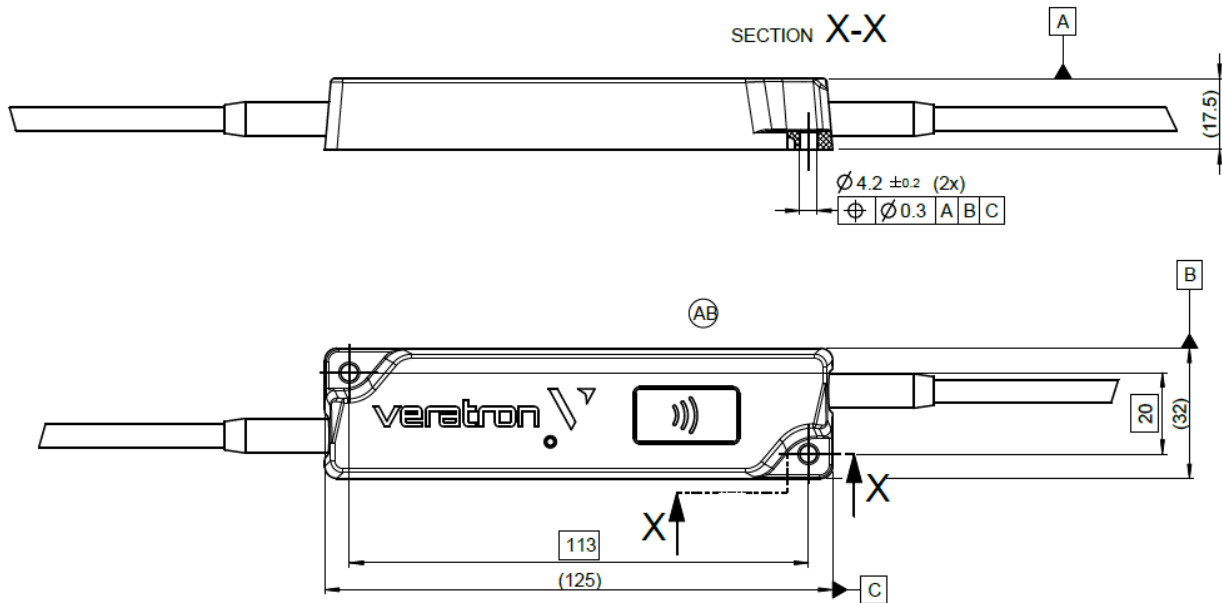

PINOUT

Pin No.	Description
1	Shield
2	NET-S (V+)
3	NET-C (V-)
4	NET-H (CAN H)
5	NET-L (CAN L)

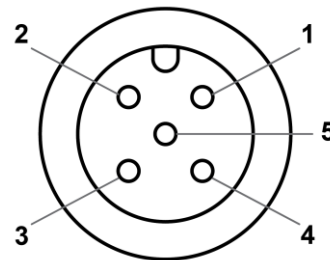

Figure 5:
Micro-C M12 5 poles plug
Male, product side view

Pin No.	Description
1	Sensor GND
2	Sensor signal

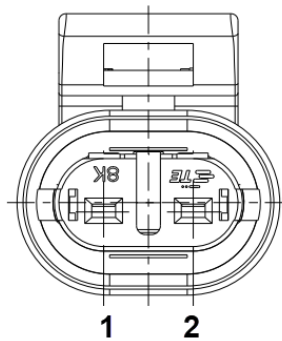

Figure 6:
Sensor plug
Female, product side view

SUPPORTED NMEA 2000® PGNs

Description	PGN
ISO Address Claim	60928
ISO Request	59904
ISO Transport Protocol, Data Transfer	60160
ISO Transport Protocol, Connection Management	60416
ISO Acknowledgment	59392
NMEA - Request group function	126208
Heartbeat	126993
Configuration Information	126998
Product Information	126996
PGN List - Received PGNs group function	126464
Rudder	127245
Fluid Level	127505
Engine Parameters, Rapid Update	127488
Engine Parameters, Dynamic	127489
Transmission Parameters, Dynamic	127493
Trim Tab Status	130576



veratron AG
Industriestrasse 18
9464 Rüthi, Switzerland

T +41 71 7679 111
info@veratron.com
veratron.com

Any distribution, translation or reproduction, partial or total, of the document is strictly prohibited unless with prior authorization in writing from veratron AG, except for the following actions:

- Printing the document in its original format, totally or partially.
- Copying contents without any modifications and stating Veratron AG as copyright owner.

Veratron AG reserves the right to make modifications or improvements to the relative documentation without notice.

Requests for authorization, additional copies of this manual or technical information on the latter, must be addressed to veratron AG.