

Ø 85 mm Gauges front fitting

Flat bezel

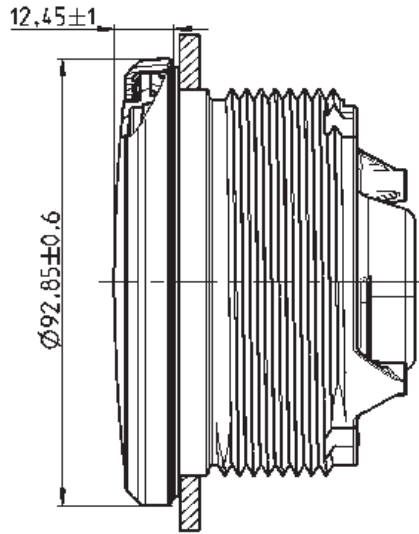

Round bezel

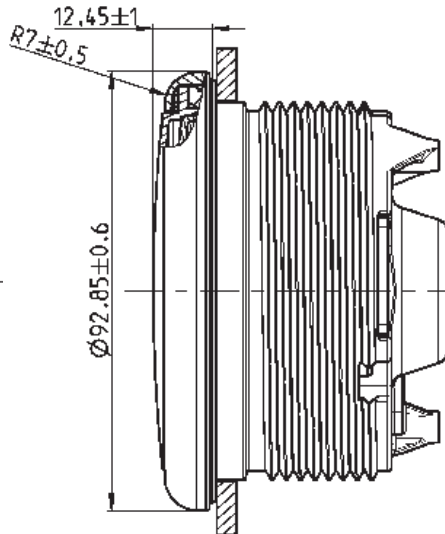

Triangle bezel

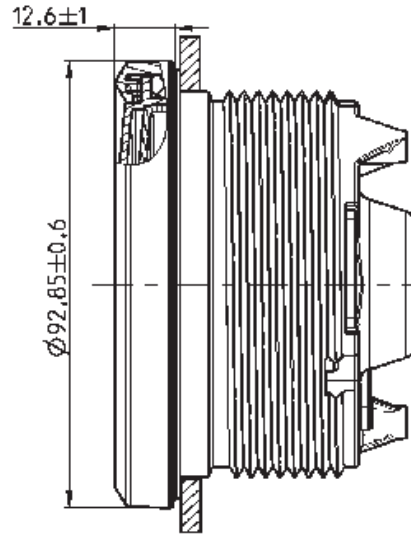

Ø 85 mm Gauges flush fitting

No bezel (rear entry)

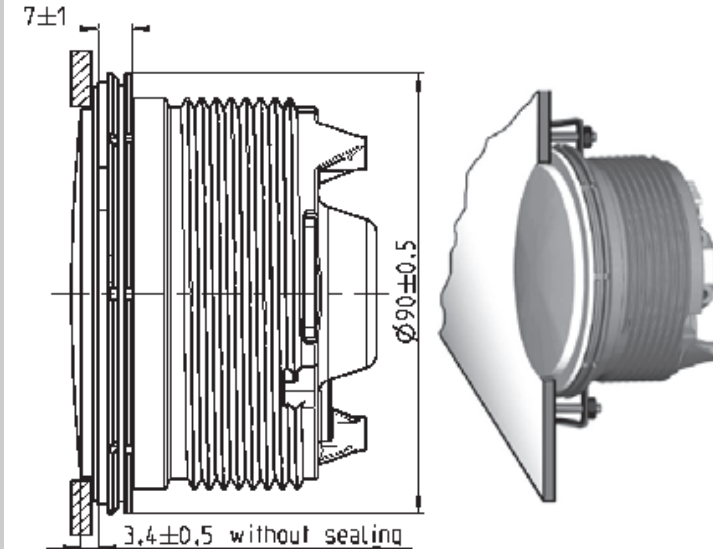

Ø 85 mm Gauge and Clamp-Ring overall dimension

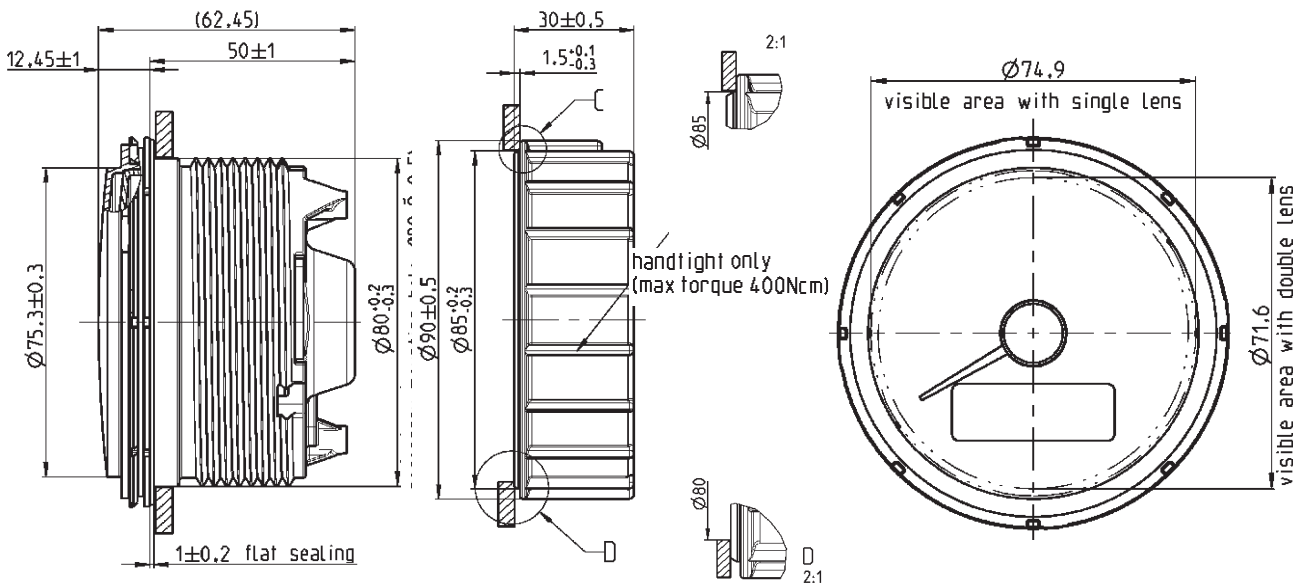

Ø 85 mm Gauges & Brackets

